

# Cat® 3516B

## Diesel Generator Sets



Image shown may not reflect actual configuration

Bore – mm (in)	170 (6.69)
Stroke – mm (in)	215 (8.46)
Displacement – L (in <sup>3</sup> )	78 (4764.73)
Compression Ratio	15.5:1
Aspiration	TA
Fuel System	EUI
Governor Type	ADEM™ A3

Standby 50 Hz kVA (ekW)	Mission Critical 50 Hz kVA (ekW)	Prime 50 Hz kVA (ekW)	Continuous 50 Hz kVA (ekW)	Emissions Performance
2500 (2000)	2500 (2000)	2275 (1820)	2000 (1600)	Optimized for Low Fuel Consumption and Low Emissions

### Standard Features

#### Cat® Diesel Engine

- Designed and optimized for low emissions or low fuel consumption
- Reliable performance proven in thousands of applications worldwide

#### Generator Set Package

- Accepts 100% block load in one step and meets NFPA 110 loading requirements
- Conforms to ISO 8528-5 G3 load acceptance requirements
- Reliability verified through torsional vibration, fuel consumption, oil consumption, transient performance, and endurance testing

#### Alternators

- Superior motor starting capability minimizes need for oversizing generator
- Designed to match performance and output characteristics of Cat diesel engines

#### Cooling System

- Cooling systems available to operate in ambient temperatures up to 50°C (122°F)
- Tested to ensure proper generator set cooling

#### EMCP 4 Control Panels

- User-friendly interface and navigation
- Scalable system to meet a wide range of installation requirements
- Expansion modules and site specific programming for specific customer requirements

#### Warranty

- 24 months/1000-hour warranty for standby and mission critical ratings
- 12 months/unlimited hour warranty for prime and continuous ratings
- Extended service protection is available to provide extended coverage options

#### Worldwide Product Support

- Cat dealers have over 1,800 dealer branch stores operating in 200 countries
- Your local Cat dealer provides extensive post-sale support, including maintenance and repair agreements

#### Financing

- Caterpillar offers an array of financial products to help you succeed through financial service excellence
- Options include loans, finance lease, operating lease, working capital, and revolving line of credit
- Contact your local Cat dealer for availability in your region

## Optional Equipment

### Engine

#### Air Cleaner

- Single element
- Dual element
- Heavy duty

#### Muffler

- Industrial grade (10 dB)
- Industrial grade (15 dB)
- Residential grade (20 dB)
- Critical grade (35 dB)

#### Starting

- Standard batteries
- Oversized batteries
- Standard electric starter(s)
- Dual electric starter(s)
- Air starter(s)
- Jacket water heater

### Alternator

#### Output voltage

- 380V     6600V
- 400V     6900V
- 415V     10000V
- 3300V     10500V
- 6300V     11000V

#### Temperature Rise (over 40°C ambient)

- 150°C
- 125°C/130°C
- 105°C
- 80°C

#### Winding type

- Random wound
- Form wound

#### Excitation

- Internal excitation (IE)
- Permanent magnet (PM)

#### Attachments

- Anti-condensation heater
- Stator and bearing temperature monitoring and protection

### Power Termination

#### Type

- Bus bar
- Circuit breaker
- 1600A     2000A
- 2500A     3000A
- 3200A
- UL         IEC
- 3-pole     4-pole
- Manually operated
- Electrically operated

#### Trip Unit

- LSI         LSI-G
- LSI-G-P

### Control System

#### Controller

- EMCP 4.2B
- EMCP 4.3
- EMCP 4.4

#### Attachments

- Local annunciator module
- Remote annunciator module
- Expansion I/O module
- Remote monitoring software

### Charging

- Battery charger – 10A
- Battery charger – 20A
- Battery charger – 35A

### Vibration Isolators

- Rubber
- Spring
- Seismic rated

### Cat Connect

#### Connectivity

- Ethernet
- Cellular
- Satellite

### Extended Service Options

#### Terms

- 2 year (prime)
- 3 year
- 5 year
- 10 year

#### Coverage

- Silver
- Gold
- Platinum
- Platinum Plus

### Ancillary Equipment

- Automatic transfer switch (ATS)
- Uninterruptible power supply (UPS)
- Paralleling switchgear
- Paralleling controls

### Certifications

- IBC seismic certification
- EU Declaration of Conformity
- EU Declaration of Incorporation
- Eurasian Conformity (EAC)

**Note:** Some options may not be available on all models. Certifications may not be available with all model configurations. Consult factory for availability.

## Package Performance

### Low Fuel Consumption (30°C SCAC)

Performance	Standby		Mission Critical		Prime		Continuous	
Frequency	50 Hz		50 Hz		50 Hz		50 Hz	
Gen set power rating with fan	2000 ekW		2000 ekW		1820 ekW		1600 ekW	
Gen set power rating with fan @ 0.8 power factor	2500 kVA		2500 kVA		2275 kVA		2000 kVA	
Emissions	Low Fuel		Low Fuel		Low Fuel		Low Fuel	
Performance number	EM2644-00		EM2647-00		DM7967-02		DM7970-01	
Aftercooler (separate circuit) – °C (°F)	30	(86)	30	(86)	30	(86)	30	(86)
<b>Fuel Consumption</b>								
100% load with fan – L/hr (gal/hr)	501.5	(132.5)	501.5	(132.5)	453.9	(119.9)	396.1	(104.6)
75% load with fan – L/hr (gal/hr)	370.5	(97.9)	370.5	(97.9)	335.8	(88.7)	295.7	(78.1)
50% load with fan – L/hr (gal/hr)	251.0	(66.3)	251.0	(66.3)	230.8	(61.0)	206.7	(54.6)
25% load with fan – L/hr (gal/hr)	143.8	(38.0)	143.8	(38.0)	133.9	(35.4)	122.1	(32.3)
<b>Cooling System</b>								
Radiator air flow restriction (system) – kPa (in. water)	0.12	(0.48)	0.12	(0.48)	0.12	(0.48)	0.12	(0.48)
Radiator air flow – m <sup>3</sup> /min (cfm)	2254.0	(79599)	2254.0	(79599)	2254.0	(79599)	2254.0	(79599)
Engine coolant capacity – L (gal)	233.0	(61.6)	233.0	(61.6)	233.0	(61.6)	233.0	(61.6)
Radiator coolant capacity – L (gal)	131.0	(34.6)	131.0	(34.6)	131.0	(34.6)	131.0	(34.6)
Total coolant capacity – L (gal)	364.0	(96.2)	364.0	(96.2)	364.0	(96.2)	364.0	(96.2)
<b>Inlet Air</b>								
Combustion air inlet flow rate – m <sup>3</sup> /min (cfm)	160.5	(5667.4)	160.5	(5667.4)	152.7	(5391.9)	139.8	(4936.5)
<b>Exhaust System</b>								
Exhaust stack gas temperature – °C (°F)	480.8	(897.4)	480.8	(897.4)	456.4	(853.5)	432.9	(811.2)
Exhaust gas flow rate – m <sup>3</sup> /min (cfm)	425.9	(15038.9)	425.9	(15038.9)	391.3	(13816.9)	346.5	(12235.4)
Exhaust system backpressure (maximum allowable) – kPa (in. water)	6.7	(27.0)	6.7	(27.0)	6.7	(27.0)	6.7	(27.0)
<b>Heat Rejection</b>								
Heat rejection to jacket water – kW (Btu/min)	626	(35600)	626	(35600)	858	(33268)	533	(30312)
Heat rejection to exhaust (total) – kW (Btu/min)	1900	(108051)	1900	(108051)	1707	(97074)	1477	(83997)
Heat rejection to aftercooler – kW (Btu/min)	525	(29856)	525	(29856)	459	(26102)	378	(21497)
Heat rejection to atmosphere from engine – kW (Btu/min)	142	(8075)	142	(8075)	133	(7564)	124	(7052)
Heat rejection from alternator – kW (Btu/min)	94	(5362)	94	(5362)	83	(4713)	72	(4093)
<b>Emissions* (Nominal)</b>								
NOx mg/Nm <sup>3</sup> (g/hp-h)	2923.5	(5.94)	2923.5	(5.94)	2799.1	(5.65)	2935.2	(5386)
CO mg/Nm <sup>3</sup> (g/hp-h)	232.1	(0.47)	232.1	(0.47)	153.6	(0.31)	89.2	(0.18)
HC mg/Nm <sup>3</sup> (g/hp-h)	69.2	(0.14)	69.2	(0.14)	72.5	(0.15)	73.8	(0.15)
PM mg/Nm <sup>3</sup> (g/hp-h)	22.5	(0.05)	22.5	(0.05)	17.9	(0.04)	12.0	(0.02)
<b>Emissions* (Potential Site Variation)</b>								
NOx mg/Nm <sup>3</sup> (g/hp-h)	3508.2	(7.13)	3508.2	(7.13)	3359.0	(6.78)	3522.2	(7.04)
CO mg/Nm <sup>3</sup> (g/hp-h)	417.8	(0.85)	417.8	(0.85)	276.5	(0.56)	160.6	(0.32)
HC mg/Nm <sup>3</sup> (g/hp-h)	92.0	(0.19)	92.0	(0.19)	96.4	(0.19)	98.2	(0.20)
PM mg/Nm <sup>3</sup> (g/hp-h)	31.5	(0.06)	31.5	(0.06)	25.1	(0.05)	16.8	(0.03)

\*mg/Nm<sup>3</sup> levels are corrected to 5% O<sub>2</sub>. Contact your local Cat dealer for further information.

## Package Performance

### Low Fuel Consumption (60°C SCAC)

Performance	Standby		Mission Critical		Prime		Continuous	
Frequency	50 Hz		50 Hz		50 Hz		50 Hz	
Gen set power rating with fan	2000 ekW		2000 ekW		1820 ekW		1600 ekW	
Gen set power rating with fan @ 0.8 power factor	2500 kVA		2500 kVA		2275 kVA		2000 kVA	
Emissions	Low Fuel		Low Fuel		Low Fuel		Low Fuel	
Performance number	EM2645-00		EM2648-00		DM7968-02		DM7971-01	
Aftercooler (separate circuit) – °C (°F)	60	(140)	60	(140)	60	(140)	60	(140)
<b>Fuel Consumption</b>								
100% load with fan – L/hr (gal/hr)	506.9	(133.9)	506.9	(133.9)	460.6	(121.7)	400.8	(105.9)
75% load with fan – L/hr (gal/hr)	375.1	(99.1)	375.1	(99.1)	340.7	(90.0)	301.3	(79.6)
50% load with fan – L/hr (gal/hr)	257.0	(67.9)	257.0	(67.9)	236.4	(62.4)	211.7	(55.9)
25% load with fan – L/hr (gal/hr)	146.7	(38.8)	146.7	(38.8)	136.4	(36.0)	124.1	(32.8)
<b>Cooling System</b>								
Radiator air flow restriction (system) – kPa (in. water)	0.12	(0.48)	0.12	(0.48)	0.12	(0.48)	0.12	(0.48)
Radiator air flow – m <sup>3</sup> /min (cfm)	2254.0	(79599)	2254.0	(79599)	2254.0	(79599)	2254.0	(79599)
Engine coolant capacity – L (gal)	233.0	(61.6)	233.0	(61.6)	233.0	(61.6)	233.0	(61.6)
Radiator coolant capacity – L (gal)	131.0	(34.6)	131.0	(34.6)	131.0	(34.6)	131.0	(34.6)
Total coolant capacity – L (gal)	364.0	(96.2)	364.0	(96.2)	364.0	(96.2)	364.0	(96.2)
<b>Inlet Air</b>								
Combustion air inlet flow rate – m <sup>3</sup> /min (cfm)	155.1	(5476.7)	155.1	(5476.7)	147.5	(5208.3)	133.7	(4721.1)
<b>Exhaust System</b>								
Exhaust stack gas temperature – °C (°F)	510.2	(950.4)	510.2	(950.4)	489.0	(912.2)	467.8	(874.0)
Exhaust gas flow rate – m <sup>3</sup> /min (cfm)	428.0	(15113.0)	428.0	(15113.0)	395.4	(13961.6)	348.1	(12291.9)
Exhaust system backpressure (maximum allowable) – kPa (in. water)	6.7	(27.0)	6.7	(27.0)	6.7	(27.0)	6.7	(27.0)
<b>Heat Rejection</b>								
Heat rejection to jacket water – kW (Btu/min)	684	(38898)	684	(38898)	639	(36339)	583	(33155)
Heat rejection to exhaust (total) – kW (Btu/min)	1965	(111748)	1965	(111748)	1775	(100941)	1548	(88035)
Heat rejection to aftercooler – kW (Btu/min)	452	(25705)	452	(25705)	388	(22065)	309	(17573)
Heat rejection to atmosphere from engine – kW (Btu/min)	153	(8701)	153	(8701)	144	(8189)	135	(7677)
Heat rejection from alternator – kW (Btu/min)	94	(5362)	94	(5362)	83	(4713)	72	(4093)
<b>Emissions* (Nominal)</b>								
NOx mg/Nm <sup>3</sup> (g/hp-h)	3256.7	(6.69)	3256.7	(6.69)	3066.9	(6.28)	3249.6	(6.57)
CO mg/Nm <sup>3</sup> (g/hp-h)	291.2	(0.60)	291.2	(0.60)	209.8	(0.43)	109.1	(0.22)
HC mg/Nm <sup>3</sup> (g/hp-h)	65.4	(0.13)	65.4	(0.13)	67.7	(0.14)	74.2	(0.15)
PM mg/Nm <sup>3</sup> (g/hp-h)	32.6	(0.07)	32.6	(0.07)	19.5	(0.04)	13.1	(0.03)
<b>Emissions* (Potential Site Variation)</b>								
NOx mg/Nm <sup>3</sup> (g/hp-h)	3908.0	(8.02)	3908.0	(8.02)	3680.3	(7.54)	3899.6	(7.88)
CO mg/Nm <sup>3</sup> (g/hp-h)	524.2	(1.08)	524.2	(1.08)	377.6	(0.77)	196.4	(0.40)
HC mg/Nm <sup>3</sup> (g/hp-h)	87.0	(0.18)	87.0	(0.18)	90.0	(0.18)	98.7	(0.20)
PM mg/Nm <sup>3</sup> (g/hp-h)	45.6	(0.09)	45.6	(0.09)	27.3	(0.06)	18.3	(0.04)

\*mg/Nm<sup>3</sup> levels are corrected to 5% O<sub>2</sub>. Contact your local Cat dealer for further information.

## Package Performance

### Low Fuel Consumption (90°C SCAC)

Performance	Standby		Mission Critical		Prime		Continuous	
Frequency	50 Hz		50 Hz		50 Hz		50 Hz	
Gen set power rating with fan	2000 ekW		2000 ekW		1820 ekW		1600 ekW	
Gen set power rating with fan @ 0.8 power factor	2500 kVA		2500 kVA		2275 kVA		2000 kVA	
Emissions	Low Fuel		Low Fuel		Low Fuel		Low Fuel	
Performance number	EM2646-00		EM2649-00		DM7969-01		DM7972-01	
Aftercooler (separate circuit) – °C (°F)	90	(194)	90	(194)	90	(194)	90	(194)
<b>Fuel Consumption</b>								
100% load with fan – L/hr (gal/hr)	519.8	(137.3)	519.8	(137.3)	471.0	(124.4)	409.1	(108.1)
75% load with fan – L/hr (gal/hr)	382.2	(101.0)	382.2	(101.0)	346.3	(91.5)	305.5	(80.6)
50% load with fan – L/hr (gal/hr)	260.1	(68.7)	260.1	(68.7)	239.2	(63.2)	213.8	(56.5)
25% load with fan – L/hr (gal/hr)	146.1	(38.6)	146.1	(38.6)	135.4	(35.8)	122.9	(32.5)
<b>Cooling System</b>								
Radiator air flow restriction (system) – kPa (in. water)	0.12	(0.48)	0.12	(0.48)	0.12	(0.48)	0.12	(0.48)
Radiator air flow – m <sup>3</sup> /min (cfm)	2254.0	(79599)	2254.0	(79599)	2254.0	(79599)	2254.0	(79599)
Engine coolant capacity – L (gal)	233.0	(61.6)	233.0	(61.6)	233.0	(61.6)	233.0	(61.6)
Radiator coolant capacity – L (gal)	131.0	(34.6)	131.0	(34.6)	131.0	(34.6)	131.0	(34.6)
Total coolant capacity – L (gal)	364.0	(96.2)	364.0	(96.2)	364.0	(96.2)	364.0	(96.2)
<b>Inlet Air</b>								
Combustion air inlet flow rate – m <sup>3</sup> /min (cfm)	151.7	(5356.6)	151.7	(5356.6)	143.9	(5081.2)	129.7	(4579.9)
<b>Exhaust System</b>								
Exhaust stack gas temperature – °C (°F)	554.3	(1029.7)	554.3	(1029.7)	531.9	(989.4)	508.8	(947.8)
Exhaust gas flow rate – m <sup>3</sup> /min (cfm)	443.2	(15649.7)	443.2	(15649.7)	407.5	(14388.9)	356.7	(12595.6)
Exhaust system backpressure (maximum allowable) – kPa (in. water)	6.7	(27.0)	6.7	(27.0)	6.7	(27.0)	6.7	(27.0)
<b>Heat Rejection</b>								
Heat rejection to jacket water – kW (Btu/min)	751	(42709)	751	(42709)	702	(39922)	640	(36397)
Heat rejection to exhaust (total) – kW (Btu/min)	2080	(118288)	2080	(118288)	1884	(107139)	1646	(93608)
Heat rejection to aftercooler – kW (Btu/min)	379	(21553)	379	(21553)	314	(17856)	239	(13592)
Heat rejection to atmosphere from engine – kW (Btu/min)	166	(9440)	166	(9440)	157	(8928)	147	(8360)
Heat rejection from alternator – kW (Btu/min)	94	(5362)	94	(5362)	83	(4713)	72	(4093)
<b>Emissions* (Nominal)</b>								
NOx mg/Nm <sup>3</sup> (g/hp-h)	3351.3	(7.04)	3351.3	(7.04)	3225.6	(6.75)	3446.1	(7.10)
CO mg/Nm <sup>3</sup> (g/hp-h)	387.1	(0.81)	387.1	(0.81)	3073	(0.64)	163.3	(0.34)
HC mg/Nm <sup>3</sup> (g/hp-h)	53.1	(0.11)	53.1	(0.11)	60.5	(0.13)	70.7	(0.15)
PM mg/Nm <sup>3</sup> (g/hp-h)	26.8	(0.06)	26.8	(0.06)	22.3	(0.05)	14.3	(0.03)
<b>Emissions* (Potential Site Variation)</b>								
NOx mg/Nm <sup>3</sup> (g/hp-h)	4021.6	(8.45)	4021.6	(8.45)	3870.8	(8.10)	4135.4	(8.52)
CO mg/Nm <sup>3</sup> (g/hp-h)	696.8	(1.46)	696.8	(1.46)	553.1	(1.16)	294.0	(0.61)
HC mg/Nm <sup>3</sup> (g/hp-h)	70.6	(0.15)	70.6	(0.15)	80.5	(0.17)	94.0	(0.19)
PM mg/Nm <sup>3</sup> (g/hp-h)	37.5	(0.08)	37.5	(0.08)	31.2	(0.07)	20.0	(0.04)

\*mg/Nm<sup>3</sup> levels are corrected to 5% O<sub>2</sub>. Contact your local Cat dealer for further information.

## Package Performance

### Low Emissions (30°C SCAC)

Performance	Standby		Mission Critical		Prime		Continuous	
Frequency	50 Hz		50 Hz		50 Hz		50 Hz	
Gen set power rating with fan	2000 ekW		2000 ekW		1820 ekW		1600 ekW	
Gen set power rating with fan @ 0.8 power factor	2500 kVA		2500 kVA		2275 kVA		2000 kVA	
Emissions	Low Emissions		Low Emissions		Low Emissions		Low Emissions	
Performance number	EM2650-00		EM2653-00		DM7976-01		DM7979-02	
Aftercooler (separate circuit) – °C (°F)	30	(86)	30	(86)	30	(86)	30	(86)
<b>Fuel Consumption</b>								
100% load with fan – L/hr (gal/hr)	542.6	(143.3)	542.6	(143.3)	488.3	(129.0)	437.3	(115.5)
75% load with fan – L/hr (gal/hr)	409.8	(108.2)	409.8	(108.2)	371.7	(98.2)	326.3	(86.2)
50% load with fan – L/hr (gal/hr)	273.4	(72.2)	273.4	(72.2)	249.2	(65.8)	220.9	(58.4)
25% load with fan – L/hr (gal/hr)	150.0	(39.6)	150.0	(39.6)	139.3	(36.8)	126.5	(33.4)
<b>Cooling System</b>								
Radiator air flow restriction (system) – kPa (in. water)	0.12	(0.48)	0.12	(0.48)	0.12	(0.48)	0.12	(0.48)
Radiator air flow – m <sup>3</sup> /min (cfm)	2254.0	(79599)	2254.0	(79599)	2254.0	(79599)	2254.0	(79599)
Engine coolant capacity – L (gal)	233.0	(61.6)	233.0	(61.6)	233.0	(61.6)	233.0	(61.6)
Radiator coolant capacity – L (gal)	131.0	(34.6)	131.0	(34.6)	131.0	(34.6)	131.0	(34.6)
Total coolant capacity – L (gal)	364.0	(96.2)	364.0	(96.2)	364.0	(96.2)	364.0	(96.2)
<b>Inlet Air</b>								
Combustion air inlet flow rate – m <sup>3</sup> /min (cfm)	178.8	(6313.6)	178.8	(6313.6)	171.4	(6052.2)	163.8	(5784.0)
<b>Exhaust System</b>								
Exhaust stack gas temperature – °C (°F)	511.1	(952.0)	511.1	(952.0)	473.5	(884.3)	451.0	(843.8)
Exhaust gas flow rate – m <sup>3</sup> /min (cfm)	487.6	(17217.5)	487.6	(17217.5)	444.0	(15677.8)	410.4	(14491.8)
Exhaust system backpressure (maximum allowable) – kPa (in. water)	6.7	(27.0)	6.7	(27.0)	6.7	(27.0)	6.7	(27.0)
<b>Heat Rejection</b>								
Heat rejection to jacket water – kW (Btu/min)	662	(37647)	662	(37647)	617	(35088)	563	(32018)
Heat rejection to exhaust (total) – kW (Btu/min)	2228	(126704)	2228	(126704)	1984	(112828)	1726	(98158)
Heat rejection to aftercooler – kW (Btu/min)	629	(35771)	629	(35771)	560	(31845)	474	(26957)
Heat rejection to atmosphere from engine – kW (Btu/min)	153	(8701)	153	(8701)	141	(8019)	131	(7450)
Heat rejection from alternator – kW (Btu/min)	94	(5362)	94	(5362)	83	(4713)	72	(4093)
<b>Emissions* (Nominal)</b>								
NOx mg/Nm <sup>3</sup> (g/hp-h)	1813.3	(3.97)	1813.3	(3.97)	1742.2	(3.77)	1488.4	(3.28)
CO mg/Nm <sup>3</sup> (g/hp-h)	462.8	(1.01)	462.8	(1.01)	222.2	(0.48)	261.4	(0.58)
HC mg/Nm <sup>3</sup> (g/hp-h)	47.7	(0.11)	47.7	(0.11)	60.9	(0.13)	65.4	(0.14)
PM mg/Nm <sup>3</sup> (g/hp-h)	42.3	(0.09)	42.3	(0.09)	35.5	(0.08)	29.5	(0.07)
<b>Emissions* (Potential Site Variation)</b>								
NOx mg/Nm <sup>3</sup> (g/hp-h)	2176.0	(4.77)	2176.0	(4.77)	2090.6	(4.53)	1786.1	(3.94)
CO mg/Nm <sup>3</sup> (g/hp-h)	833.0	(1.82)	833.0	(1.82)	399.9	(0.87)	470.5	(1.04)
HC mg/Nm <sup>3</sup> (g/hp-h)	64.8	(0.14)	64.8	(0.14)	81.0	(0.18)	87.0	(0.19)
PM mg/Nm <sup>3</sup> (g/hp-h)	59.2	(0.13)	59.2	(0.13)	49.7	(0.11)	41.3	(0.09)

\*mg/Nm<sup>3</sup> levels are corrected to 5% O<sub>2</sub>. Contact your local Cat dealer for further information.



## Package Performance

### Low Emissions (60°C SCAC)

Performance	Standby		Mission Critical		Prime		Continuous	
Frequency	50 Hz		50 Hz		50 Hz		50 Hz	
Gen set power rating with fan	2000 ekW		2000 ekW		1820 ekW		1600 ekW	
Gen set power rating with fan @ 0.8 power factor	2500 kVA		2500 kVA		2275 kVA		2000 kVA	
Emissions	Low Emissions		Low Emissions		Low Emissions		Low Emissions	
Performance number	EM2651-00		EM2654-00		DM7977-01		DM7980-01	
Aftercooler (separate circuit) – °C (°F)	60	(140)	60	(140)	60	(140)	60	(140)
<b>Fuel Consumption</b>								
100% load with fan – L/hr (gal/hr)	547.4	(144.6)	547.4	(144.6)	497.3	(131.4)	439.8	(116.2)
75% load with fan – L/hr (gal/hr)	412.3	(108.9)	412.3	(108.9)	374.4	(98.9)	329.1	(86.9)
50% load with fan – L/hr (gal/hr)	278.8	(73.7)	278.8	(73.7)	255.6	(67.5)	227.2	(60.0)
25% load with fan – L/hr (gal/hr)	152.2	(40.2)	152.2	(40.2)	140.7	(37.2)	127.6	(33.7)
<b>Cooling System</b>								
Radiator air flow restriction (system) – kPa (in. water)	0.12	(0.48)	0.12	(0.48)	0.12	(0.48)	0.12	(0.48)
Radiator air flow – m <sup>3</sup> /min (cfm)	2254.0	(79599)	2254.0	(79599)	2254.0	(79599)	2254.0	(79599)
Engine coolant capacity – L (gal)	233.0	(61.6)	233.0	(61.6)	233.0	(61.6)	233.0	(61.6)
Radiator coolant capacity – L (gal)	131.0	(34.6)	131.0	(34.6)	131.0	(34.6)	131.0	(34.6)
Total coolant capacity – L (gal)	364.0	(96.2)	364.0	(96.2)	364.0	(96.2)	364.0	(96.2)
<b>Inlet Air</b>								
Combustion air inlet flow rate – m <sup>3</sup> /min (cfm)	174.3	(6154.7)	174.3	(6154.7)	167.6	(5918.0)	157.9	(5575.6)
<b>Exhaust System</b>								
Exhaust stack gas temperature – °C (°F)	535.3	(995.5)	535.3	(995.5)	506.3	(943.3)	476.8	(890.2)
Exhaust gas flow rate – m <sup>3</sup> /min (cfm)	490.2	(17309.3)	490.2	(17309.3)	453.7	(16020.3)	410.6	(14498.8)
Exhaust system backpressure (maximum allowable) – kPa (in. water)	6.7	(27.0)	6.7	(27.0)	6.7	(27.0)	6.7	(27.0)
<b>Heat Rejection</b>								
Heat rejection to jacket water – kW (Btu/min)	724	(41173)	724	(41173)	674	(38329)	616	(35032)
Heat rejection to exhaust (total) – kW (Btu/min)	2301	(130856)	2301	(130856)	2052	(116695)	1789	(101741)
Heat rejection to aftercooler – kW (Btu/min)	549	(31221)	549	(31221)	480	(27296)	397	(22578)
Heat rejection to atmosphere from engine – kW (Btu/min)	167	(9497)	167	(9497)	154	(8757)	143	(8132)
Heat rejection from alternator – kW (Btu/min)	94	(5362)	94	(5362)	83	(4713)	72	(4093)
<b>Emissions* (Nominal)</b>								
NOx mg/Nm <sup>3</sup> (g/hp-h)	2095.4	(4.64)	2095.4	(4.64)	1969.6	(4.35)	1796.7	(3.98)
CO mg/Nm <sup>3</sup> (g/hp-h)	560.9	(4.24)	560.9	(4.24)	400.7	(0.89)	294.2	(0.65)
HC mg/Nm <sup>3</sup> (g/hp-h)	40.9	(0.09)	40.9	(0.09)	50.3	(0.11)	65.9	(0.15)
PM mg/Nm <sup>3</sup> (g/hp-h)	64.4	(0.14)	64.4	(0.14)	50.9	(0.11)	19.4	(0.04)
<b>Emissions* (Potential Site Variation)</b>								
NOx mg/Nm <sup>3</sup> (g/hp-h)	2514.5	(5.57)	2514.5	(5.57)	2363.5	(5.22)	2156.0	(4.78)
CO mg/Nm <sup>3</sup> (g/hp-h)	1009.6	(2.23)	1009.6	(2.23)	721.3	(1.59)	529.5	(1.17)
HC mg/Nm <sup>3</sup> (g/hp-h)	54.4	(0.12)	54.4	(0.12)	66.9	(0.15)	87.6	(0.19)
PM mg/Nm <sup>3</sup> (g/hp-h)	90.2	(0.20)	90.2	(0.20)	71.3	(0.16)	27.2	(0.06)

\*mg/Nm<sup>3</sup> levels are corrected to 5% O<sub>2</sub>. Contact your local Cat dealer for further information.

## Package Performance

### Low Emissions (90°C SCAC)

Performance	Standby		Mission Critical		Prime		Continuous	
Frequency	50 Hz		50 Hz		50 Hz		50 Hz	
Gen set power rating with fan	2000 ekW		2000 ekW		1820 ekW		1600 ekW	
Gen set power rating with fan @ 0.8 power factor	2500 kVA		2500 kVA		2275 kVA		2000 kVA	
Emissions	Low Emissions		Low Emissions		Low Emissions		Low Emissions	
Performance number	EM2652-00		EM2655-00		DM7978-01		DM7981-01	
Aftercooler (separate circuit) – °C (°F)	90	(194)	90	(194)	90	(194)	90	(194)
<b>Fuel Consumption</b>								
100% load with fan – L/hr (gal/hr)	525.4	(138.8)	525.4	(138.8)	4781	(126.3)	422.3	(111.6)
75% load with fan – L/hr (gal/hr)	395.8	(104.6)	395.8	(104.6)	359.3	(94.9)	315.7	(83.4)
50% load with fan – L/hr (gal/hr)	268.5	(70.9)	268.5	(70.9)	247.0	(65.2)	221.3	(58.5)
25% load with fan – L/hr (gal/hr)	153.6	(40.6)	153.6	(40.6)	142.8	(37.7)	130.0	(34.3)
<b>Cooling System</b>								
Radiator air flow restriction (system) – kPa (in. water)	0.12	(0.48)	0.12	(0.48)	0.12	(0.48)	0.12	(0.48)
Radiator air flow – m <sup>3</sup> /min (cfm)	2254.0	(79599)	2254.0	(79599)	2254.0	(79599)	2254.0	(79599)
Engine coolant capacity – L (gal)	233.0	(61.6)	233.0	(61.6)	233.0	(61.6)	233.0	(61.6)
Radiator coolant capacity – L (gal)	131.0	(34.6)	131.0	(34.6)	131.0	(34.6)	131.0	(34.6)
Total coolant capacity – L (gal)	364.0	(96.2)	364.0	(96.2)	364.0	(96.2)	364.0	(96.2)
<b>Inlet Air</b>								
Combustion air inlet flow rate – m <sup>3</sup> /min (cfm)	158.2	(5586.2)	158.2	(5586.2)	150.7	(5321.3)	139.3	(4918.9)
<b>Exhaust System</b>								
Exhaust stack gas temperature – °C (°F)	540.0	(1004.0)	540.0	(1004.0)	519.1	(966.4)	499.8	(931.6)
Exhaust gas flow rate – m <sup>3</sup> /min (cfm)	453.6	(16017.0)	453.6	(16017.0)	540.2	(14837.4)	378.5	(13365.4)
Exhaust system backpressure (maximum allowable) – kPa (in. water)	6.7	(27.0)	6.7	(27.0)	6.7	(27.0)	6.7	(27.0)
<b>Heat Rejection</b>								
Heat rejection to jacket water – kW (Btu/min)	759	(43164)	759	(43164)	711	(40434)	651	(37022)
Heat rejection to exhaust (total) – kW (Btu/min)	2117	(120392)	2117	(120392)	1923	(109358)	1693	(96281)
Heat rejection to aftercooler – kW (Btu/min)	4006	(23089)	4006	(23089)	347	(19733)	274	(15583)
Heat rejection to atmosphere from engine – kW (Btu/min)	175	(9952)	175	(9952)	164	(9326)	153	(8701)
Heat rejection from alternator – kW (Btu/min)	94	(5362)	94	(5362)	83	(4713)	72	(4093)
<b>Emissions* (Nominal)</b>								
NOx mg/Nm <sup>3</sup> (g/hp-h)	3059.2	(6.50)	3059.2	(6.50)	3056.5	(6.50)	2749.2	(5.84)
CO mg/Nm <sup>3</sup> (g/hp-h)	323.3	(0.69)	323.3	(0.69)	323.8	(0.69)	440.8	(0.94)
HC mg/Nm <sup>3</sup> (g/hp-h)	55.2	(0.12)	55.2	(0.12)	55.3	(0.12)	64.4	(0.14)
PM mg/Nm <sup>3</sup> (g/hp-h)	12.6	(0.03)	12.6	(0.03)	12.6	(0.03)	17.2	(0.04)
<b>Emissions* (Potential Site Variation)</b>								
NOx mg/Nm <sup>3</sup> (g/hp-h)	3671.0	(7.80)	3671.0	(7.80)	3667.8	(7.80)	3299.1	(7.01)
CO mg/Nm <sup>3</sup> (g/hp-h)	581.9	(1.24)	581.9	(1.24)	582.9	(1.24)	793.5	(1.69)
HC mg/Nm <sup>3</sup> (g/hp-h)	73.4	(0.16)	73.4	(0.16)	73.6	(0.16)	85.7	(0.18)
PM mg/Nm <sup>3</sup> (g/hp-h)	17.6	(0.04)	17.6	(0.04)	17.7	(0.04)	24.1	(0.05)

\*mg/Nm<sup>3</sup> levels are corrected to 5% O<sub>2</sub>. Contact your local Cat dealer for further information.



## Weights and Dimensions

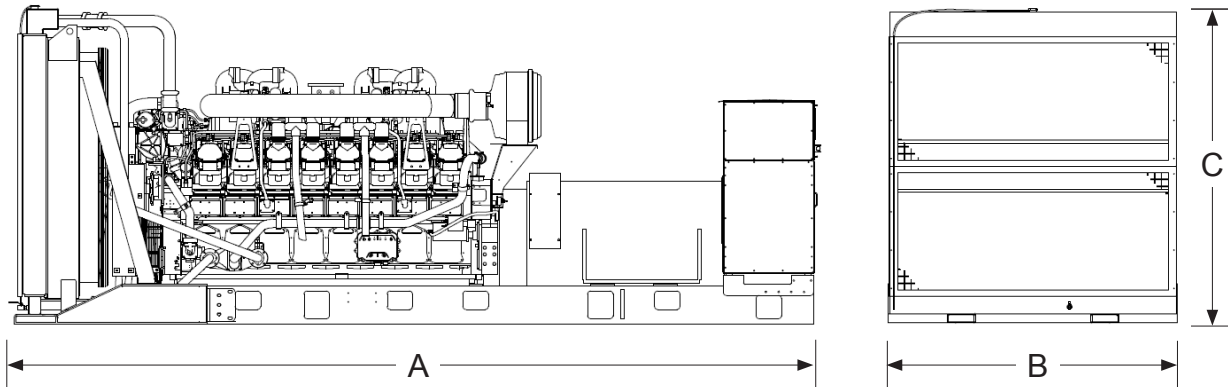

Dim "A" mm (in)	Dim "B" mm (in)	Dim "C" mm (in)	Dry Weight kg (lb)
6373 (250.9)	2286 (90.0)	2494 (98.2)	15 535 (34,250)

**Note:** For reference only. Do not use for installation design. Contact your local Cat dealer for precise weights and dimensions.

## Ratings Definitions

### Standby

Output available with varying load for the duration of the interruption of the normal source power. Average power output is 70% of the standby power rating. Typical operation is 200 hours per year, with maximum expected usage of 500 hours per year.

### Mission Critical

Output available with varying load for the duration of the interruption of the normal source power. Average power output is 85% of the mission critical power rating. Typical peak demand up to 100% of rated power for up to 5% of the operating time. Typical operation is 200 hours per year, with maximum expected usage of 500 hours per year.

### Prime

Output available with varying load for an unlimited time. Average power output is 70% of the prime power rating. Typical peak demand is 100% of prime rated kW with 10% overload capability for emergency use for a maximum of 1 hour in 12. Overload operation cannot exceed 25 hours per year.

### Continuous

Output available with non-varying load for an unlimited time. Average power output is 70-100% of the continuous power rating. Typical peak demand is 100% of continuous rated kW for 100% of the operating hours.

### Applicable Codes and Standards

AS1359, CSA C22.2 No100-04, UL142, UL489, UL869, UL2200, NFPA37, NFPA70, NFPA99, NFPA110, IBC, IEC60034-1, ISO3046, ISO8528, NEMA MG1-22, NEMA MG1-33, 2014/35/EU, 2006/42/EC, 2014/30/EU.

**Note:** Codes may not be available in all model configurations. Please consult your local Cat dealer for availability.

### Data Center Applications

Tier III/Tier IV compliant per Uptime Institute requirements. ANSI/TIA-942 compliant for Rated-1 through Rated-4 data centers.

### Fuel Rates

Fuel rates are based on fuel oil of 35° API [16°C (60°F)] gravity having an LHV of 42,780 kJ/kg (18,390 Btu/lb) when used at 29°C (85°F) and weighing 838.9 g/liter (7.001 lbs/U.S. gal.)

[www.cat.com/electricpower](http://www.cat.com/electricpower)

©2019 Caterpillar  
All rights reserved.

Materials and specifications are subject to change without notice. The International System of Units (SI) is used in this publication.